

LC Series Control Units Types 1,2 & 4 Installation and Hardware Configuration Manual

Date: 18.08.2011.
Issue: 8

STATUS SCIENTIFIC CONTROLS LTD.

Hermitage Lane Industrial Estate,
Kings Mill Way,
Mansfield,
Nottinghamshire.
NG18 5ER
England

Tel : 01623 651381

Fax : 01623 421063

Internet : www.status-scientific.com

STATUS SCIENTIFIC CONTROLS

LC Controller System Installation and Hardware Configuration Manual

The LC Controller Manuals

The LC Series Environmental Monitoring Systems have a range of manuals covering various aspects of their operation:

- **LC Controller Installation and Hardware Configuration Manual**

This manual covers all of the hardware aspects of the LC Controller. Each of the component parts of the system is discussed and hardware configuration is explained. Dimensional drawings are included.

- **LC Software Configuration and System Calibration Manual**

The operation of the LC Controller is discussed as well as the software configuration and calibration procedures.

End of Life Disposal

The LC Controller, does not represent a waste hazard but must be disposed of in accordance with the European Waste Electrical and Electronic Equipment Directive (WEEE) 2002/96/EC.

This means that it should be disposed of responsibly in accordance with an approved collection and disposal scheme or alternatively returned to Status Scientific Controls Ltd for recycling or safe disposal.

Important

Status Scientific Controls strive to continually improve their products in line with customer's requirements and technological advancement. Status Scientific reserve the right to modify the design of the system at any time.

Due to continual improvement not all of the features described within this manual may be available on earlier models, contact Status for further details.

STATUS SCIENTIFIC CONTROLS

LC Controller System Installation and Hardware Configuration Manual

1	Introduction	1-1
1.1	MICROCONTROLLER MODULE.....	1-6
1.2	INPUT CIRCUITRY	1-7
	FIELD CONNECTIONS	1-8
1.3	POWER SUPPLY MODULE	1-10
2	MCU Installation	2-1
2.1	SITING THE MCU.....	2-1
2.2	SYSTEM WIRING.....	2-2
2.3	POWER SUPPLY INPUT.....	2-2
2.3.1	<i>A.C. Mains Connection</i>	2-2
2.3.2	<i>DC Voltage Connection</i>	2-2
2.4	CABLE ROUTING.....	2-2
2.5	CABLE SCREENING.....	2-2
3	Gas Detector Head Installation	3-3
3.1	SITING THE DETECTORS	3-3
3.2	INSTALLATION IN A NON-HAZARDOUS AREA	3-3
3.3	INSTALLATION IN A HAZARDOUS AREAS.....	3-4
3.3.1	<i>Hazardous area installations using Safety Barriers</i>	3-5
4	Input Module Configuration	4-1
4.1	INPUT CONFIGURATION.....	4-2
4.2	STATUS SCIENTIFIC CONTROLS GAS DETECTORS	4-2
4.2.1	<i>FGD2, FGD3, FGD4 and FGD10b O₂ and Toxic Detector Heads</i>	4-2
4.2.2	<i>FGD3 Infrared Gas Detector Head</i>	4-4
4.2.3	<i>FGD3 Pellistor Gas Detector Head</i>	4-5
4.2.4	<i>FGD4, FGD9, FGD10a, FGD10b Gas Detector Heads</i>	4-6
4.2.5	<i>Pellistor Only Gas detectors</i>	4-8
4.2.6	<i>FGD56-IR</i>	4-10
4.3	ANALOGUE OUTPUT CONFIGURATION.....	4-11
4.3.1	<i>4-20mA Current Source</i>	4-11
4.3.2	<i>4-20mA Current Sink</i>	4-12
4.3.3	<i>1-5V Voltage Output</i>	4-13
5	Routine Servicing	5-14
5.1	ROUTINE INSPECTION	5-14
6	Dimension Details	6-1
6.1	LC1 CONTROL UNIT	6-1
6.2	LC2 CONTROL UNIT	6-2
6.3	LC4 CONTROL UNIT	6-3
7	Specifications	7-4
7.1	LC1 CONTROL UNIT	7-4
7.2	LC2 CONTROL UNIT	7-5
7.3	LC4 CONTROL UNIT	7-6

STATUS SCIENTIFIC CONTROLS

LC Series Controller Installation and Hardware Configuration Manual

1 INTRODUCTION

The LC Series Control Units that provide facilities to monitor a wide variety of industry standard environmental and other sensors.

The LC1 provides 1 monitoring channel.

The LC2 provides up to 2 monitoring channels.

The LC4 provides up to 4 monitoring channels.

The LC range has been designed primarily for environmental monitoring. However, the versatility of the range extends its application to other aspects of industry where monitoring of remotely connected sensors is required. The specification allows the use of any sensor that can produce a voltage or current output within a specified range.

Care has been taken with the design of the MCU housings and internal chassis to facilitate ease of connection and wire termination. All on-site wiring to the system is via screw terminal connectors. The terminal cover has an internal label giving details of the external connections.

A monitoring system consists of, as a minimum, an LC1 Control Unit and 1 detector head. The LC Control Unit houses all of the components required to implement a sophisticated and reliable monitoring system (alarm relays etc).

- **LC1 Control Unit.**

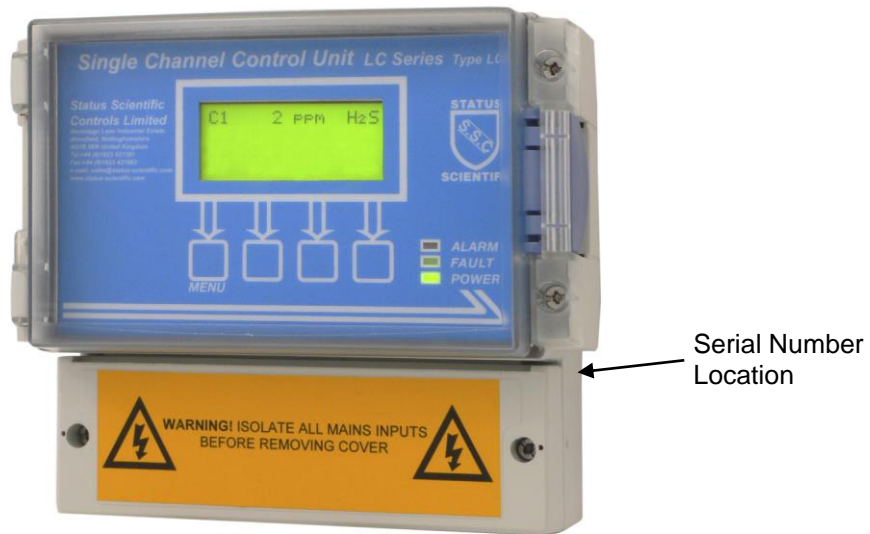

STATUS SCIENTIFIC CONTROLS

LC Series Controller Installation and Hardware Configuration Manual

- **LC2 Control Unit.**

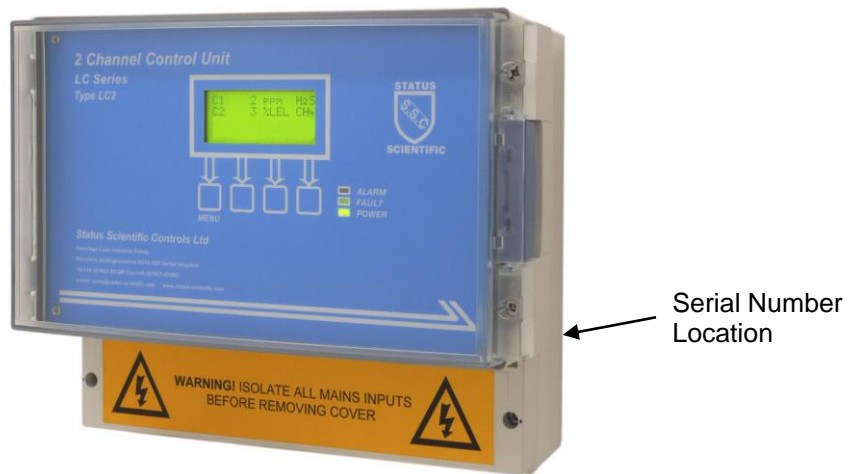

- **LC4 Control Unit**

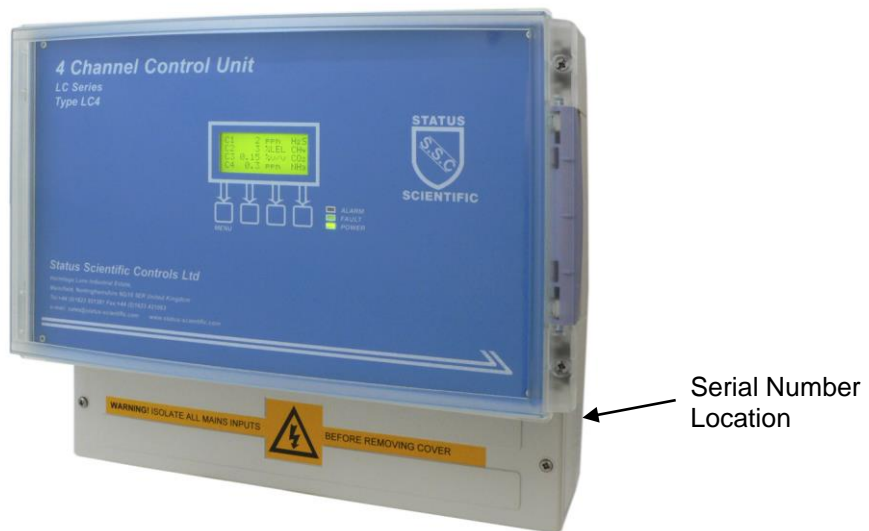

STATUS SCIENTIFIC CONTROLS

LC Series Controller Installation and Hardware Configuration Manual

The LC Series Control Units are single PCB design. Each Control Unit has a power supply section and 1, 2 or 4 I/O interface sections.

LC1

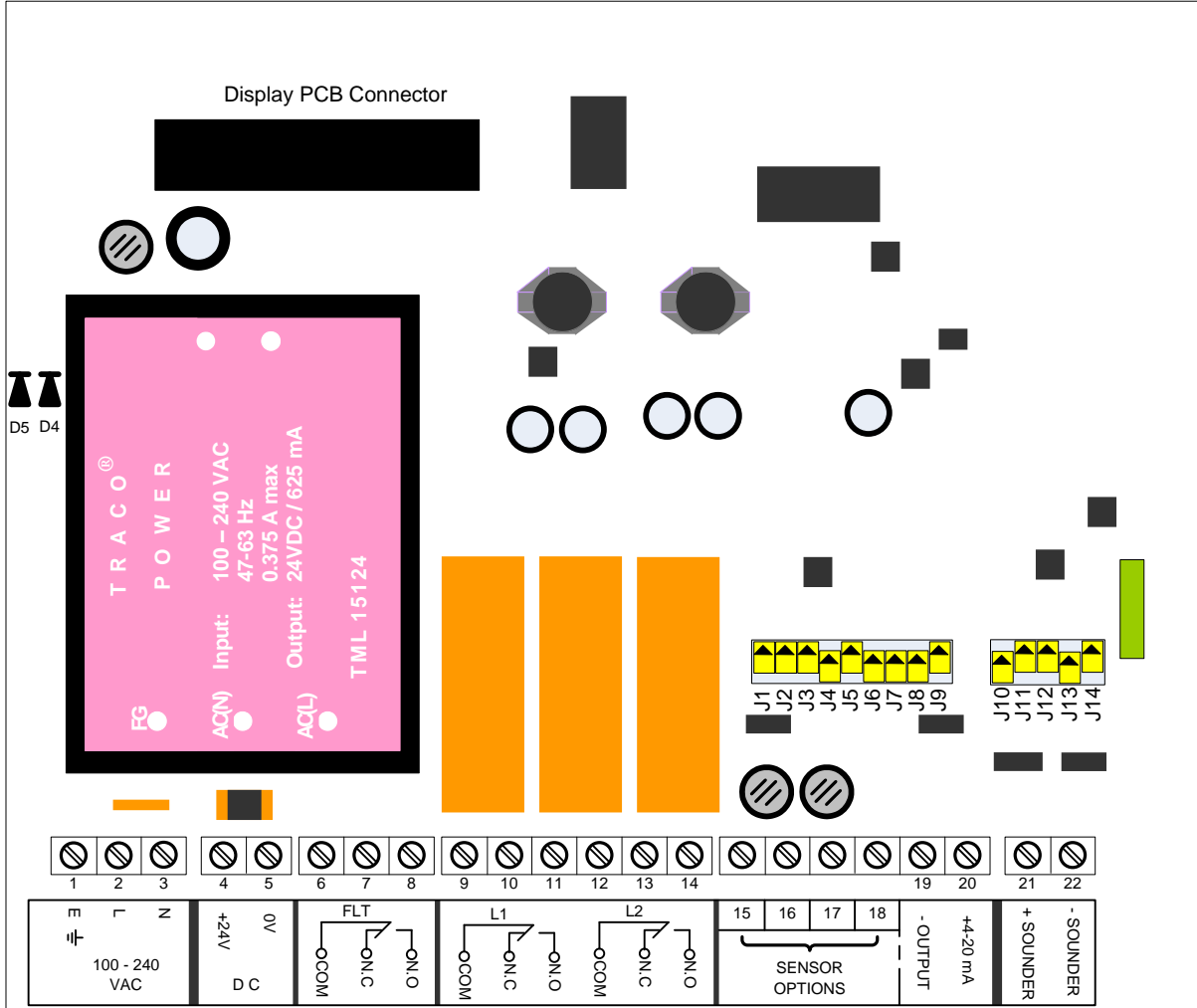

Note: D5 orientation is be selected for 24Vdc supply as follows:

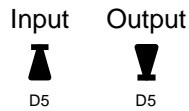

STATUS SCIENTIFIC CONTROLS

LC Series Controller Installation and Hardware Configuration Manual

LC2

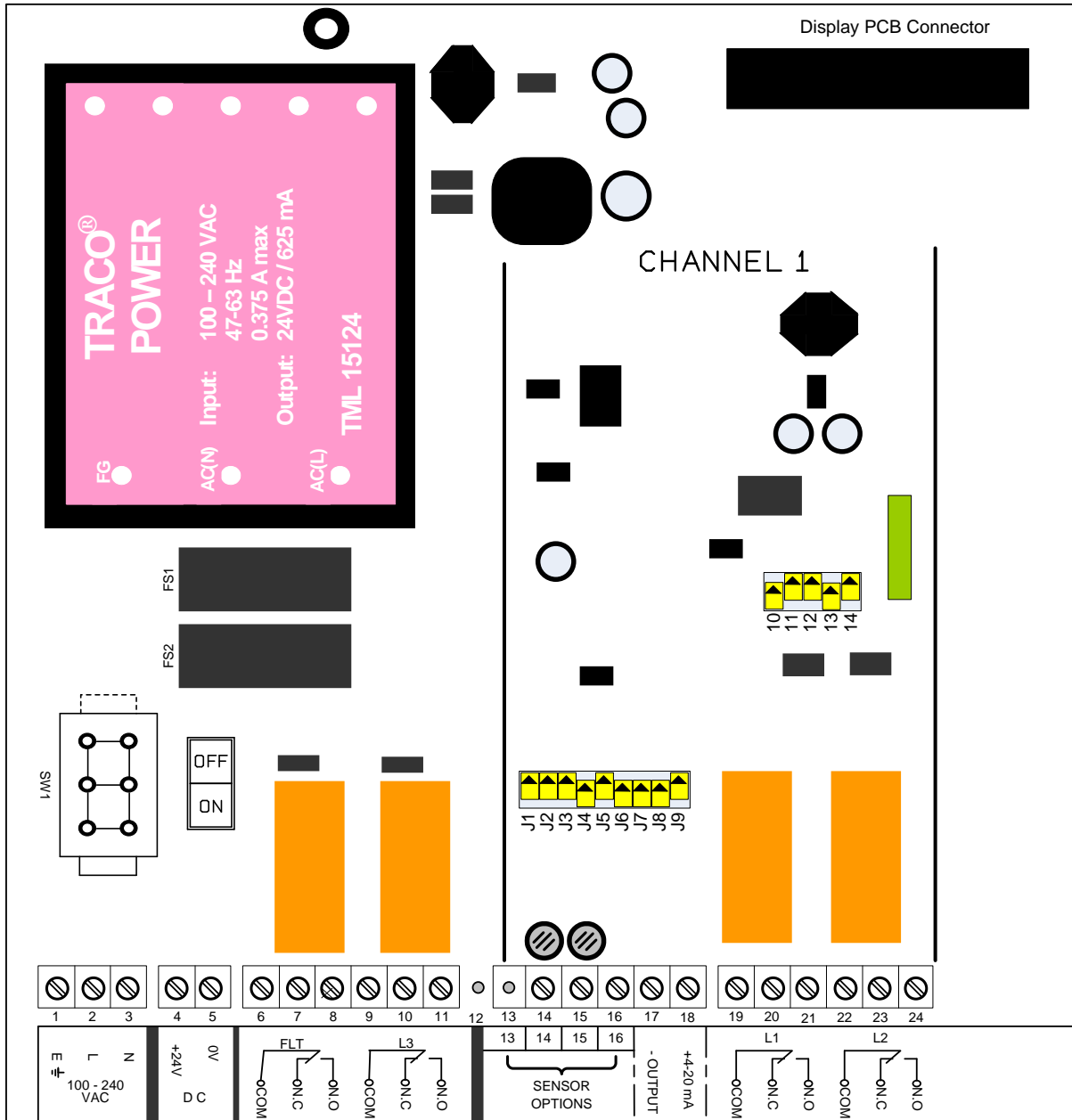

Power supply section

I/O interface section Channel 1

Note: connections 12 & 13 may not be fitted on some variants.

STATUS SCIENTIFIC CONTROLS

LC Series Controller Installation and Hardware Configuration Manual

LC4

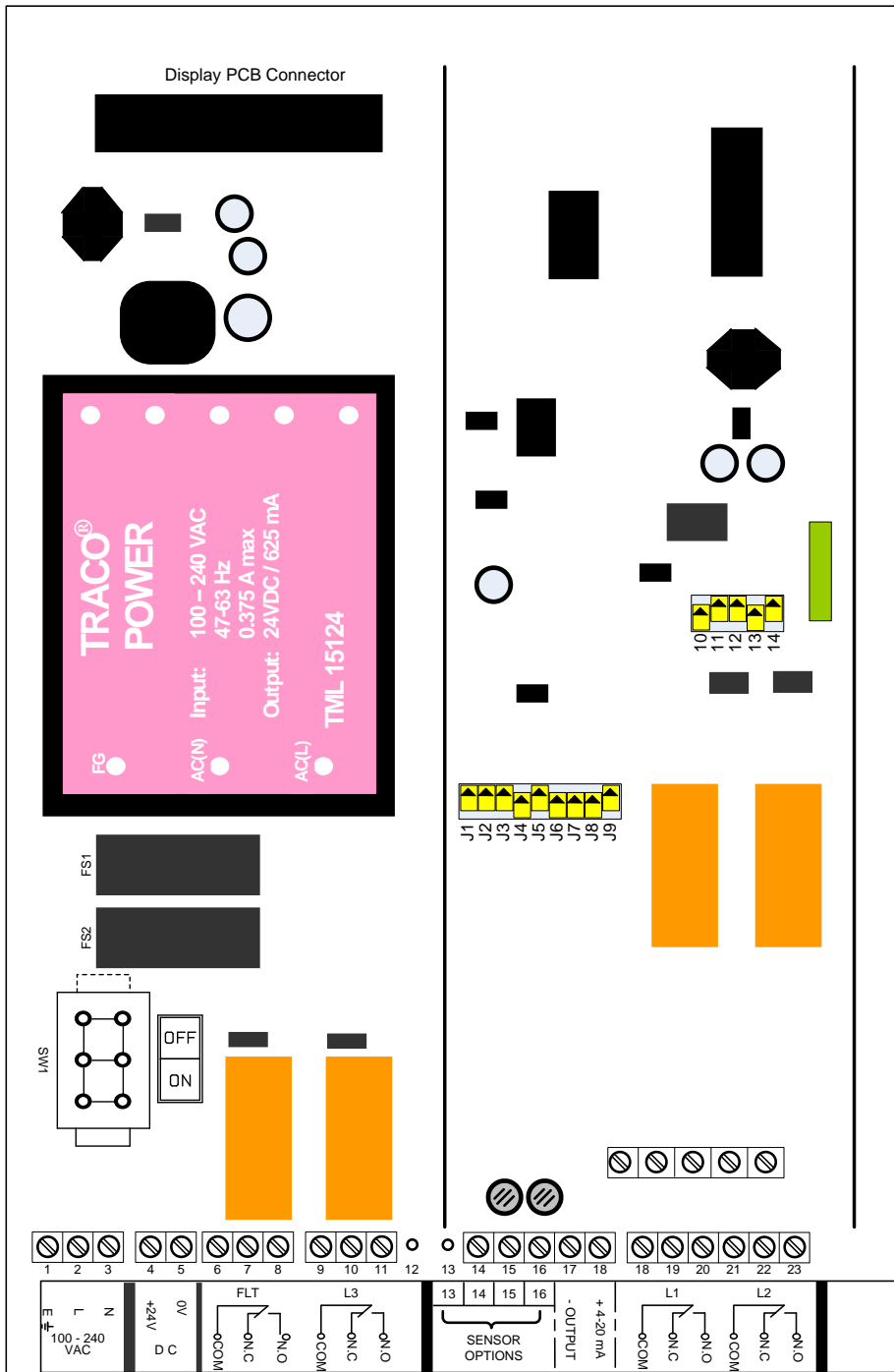

The diagrams above show a pictorial representation of the various module positions within the LCU Series Control Units

The power supply is situated on the LHS of the main PCB with the channel I/Os to the right of the PCB.

The microcontroller module and LCD display are mounted on the top of the front panel. This connects to the main PCB via a single flat ribbon cable.

Note: connections 12 & 13 may not be fitted on some variants.

STATUS SCIENTIFIC CONTROLS

LC Series Controller Installation and Hardware Configuration Manual

1.1 Microcontroller Module

Situated within the LC Control Unit front panel is the Microcontroller Module. This module communicates with all Input channels connected to the system PCB.

The Microcontroller Module provides a user interface in the form of a back lit graphics display and a four button multifunction keypad.

Three LED indications are provided directly by the Microcontroller Module and these are visible via MCU front panel:

- Green LED for power.
- Red LED indication of Alarm level 1.
- Red LED indication of Alarm level 2
- Red LED indication of alarm level 3.
- Yellow LED indication of fault condition.

An Audible signal is also provided by a sounder mounted within Microcontroller module. This provides a local audible tone during alarm or conditions.

The Microcontroller Module also provides the user with many configuration and interrogation facilities via the LCD and keypad. These facilities include:

- Sensor Configuration.
 - Allows adjustment of Sensor type and range (e.g. Flammable 100%LEL).
- Calibration of the system.
 - This allows each channel to be calibrated independently. The sensor zero point and span can both be set via this function.
 - Calibration of the retransmitted output for each channel.
 - Calibration of the channel power supply.
- Input Module Relay Configuration.
 - Each Input Module contains two relays for alarm levels 1 and 2. The alarm levels can be individually set to be either rising or falling.
 - Fault relay.
 - All relays can be configured normally energised or de-energised as required. Latching and non-latching functions can also be selected.

The microcontroller module contains all of the software required to communicate with up to four detecting channels. The software is common to all LC Series Control Units.

STATUS SCIENTIFIC CONTROLS

LC Series Controller Installation and Hardware Configuration Manual

1.2 Input Circuitry

The input circuit is identical for all channels. Each channel monitors the status of an externally attached sensor and interfaces the signals that it receives to the microcontroller module.

The input module is designed to accommodate modules that supplies it status signal in any of the following formats:

- (a) 2- wire Current source 4 – 20mA.
- (b) 3-wire power plus Current source 4 – 20mA.
- (c) 3-Wire Pellistor Systems.

In addition the input module can re-transmit the signals for use by external equipment (e.g. chart recorders). The transmitted signal can be configured using jumpers to provide one of three output options:

- 4 – 20mA Current Source proportional to the detected signal.
- 4 – 20mA Current Sink proportional to the detected signal.
- 0-5V Voltage Output proportional to the detected signal.

Situated on each Input Module are 1 Pole Change-Over Relays, each relay having contacts rated at 5A (240V AC). These relays operate at Low, and High alarm levels when enabled. Status Scientific Controls are able to implement modifications to the software to meet a customer's specific requirement. Contact Status for further information.

STATUS SCIENTIFIC CONTROLS

LC Series Controller Installation and Hardware Configuration Manual

Field Connections

Located on the bottom edge of the main PCB is a number of screw connectors. This is used to provide connections for inputs, outputs and external buttons:-

LC1

Channel 1

Pins 1, 2 and 3
AC power input.

Pins 4 and 5
24VDC power input.

Pins 6, 7 and 8
Common Fault relay contacts

Pins 9, 10 and 11
Common Alarm level 1 relay contacts

Pins 12, 13 and 14
Common Alarm level 1 relay contacts

Pins 15 to 18
I/O connection to sensors

Pins 19 to 20
4-20 mA output

LC2

Channel 1

Pins 1, 2 and 3
AC power input.

Pins 4 and 5
24VDC power input.

Pins 6, 7 and 8
Common Fault relay contacts

Pins 9, 10 and 11
Common Alarm level 3 relay contacts

Pins 13 to 16
I/O connection to sensors

Pins 17 to 18
4-20 mA output

Pins 19, 20 and 21
Alarm level 1 relay contacts

Pins 22, 23 and 24
Alarm level 2 relay contacts

Channel 2

Pins 25 to 36 are the same functions as 13 to 24.

STATUS SCIENTIFIC CONTROLS

LC Series Controller Installation and Hardware Configuration Manual

LC4

Channel 1

Connections and are the same as 13 to 24.

Channel 2

Pins 25 to 36 are the same functions as 13 to 24.

Channel 3

Pins 37 to 48 are the same functions as 13 to 24.

Channel 4

Pins 49 to 60 are the same functions as 13 to 24.

An Earth point is also provided on the main PCB.

STATUS SCIENTIFIC CONTROLS

LC Series Controller Installation and Hardware Configuration Manual

1.3 Power Supply Module

The Power Supply is situated on the LHS of the main PCB within the enclosure and provides the power for the whole system. The power supply is a standard item and does not require any modifications regardless of the type and quantity of detector heads being used.

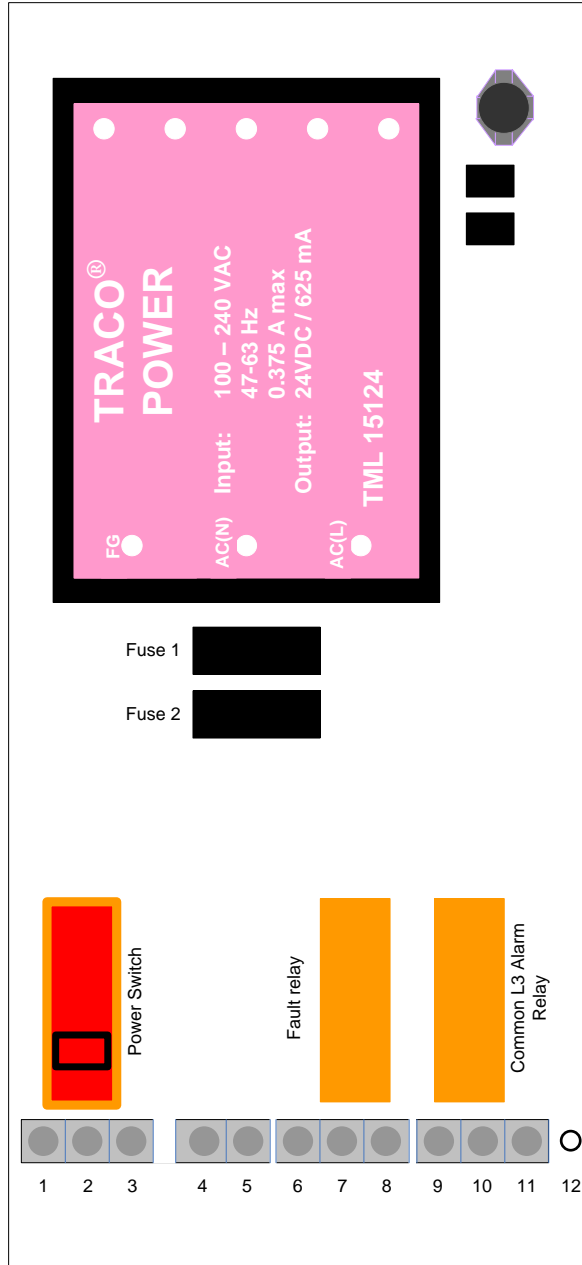

There are two power source options available to the system:

1. 100-240V AC Mains Supply, connectors 1, 2 and 3
2. 18 to 28V DC Supply, connectors 4 and 5

There are two fuses situated on the main PCB. These are:

FS1 (T1.0A) AC supply Fuse
FS2 (T500mA) DC Supply Fuse

STATUS SCIENTIFIC CONTROLS

LC Series Controller Installation and Hardware Configuration Manual

2 MCU INSTALLATION

The MCU Control Units and FGD Gas Detectors are fully tested prior to delivery. However, after installation we strongly recommend that full system testing and commissioning be carried out. Status Scientific Controls Service personnel are best equipped to perform the relevant tests and commissioning and will be able to offer advice regarding installation faults.

WARNING Installation should be made in accordance with either British Standard BS EN60079-14 (which supersedes BS5345) “Electrical Apparatus for Explosive Gas Atmospheres”, or in accordance with the relevant National or Local regulations.

CAUTION

The MCU Control Units and associated modules contain no user serviceable parts. Refer all servicing to qualified service personnel.

2.1 Siting the MCU

THE LC SERIES CONTROL UNITS MUST BE SITED IN A NON-HAZARDOUS LOCATION WHERE THERE IS NO RISK OF THE PRESENCE OF POTENTIALLY EXPLOSIVE GAS.

Either a 100-240VAC 50 Hz supply or a 24V DC supply can be used to power the control unit.

The site of installation should be chosen with regard to the following:

- This equipment should not be located near to known sources of heat.
- Operating personnel should be within convenient reach of the equipment and within audible distance of alarms.
- Maximum loop lengths of cable runs and cable inductance to resistance ratios must not exceed limits shown in the relevant loop diagrams (refer to section 3.2).
- Avoid mounting this equipment near potential sources of electrical interference e.g. motors, switch gear, radio transmitters etc.

Mounting details for the LC Controller enclosures are located within the Appendix (section 6).

STATUS SCIENTIFIC CONTROLS

LC Series Controller Installation and Hardware Configuration Manual

2.2 System Wiring

All connections should be made according to the appropriate sensor or loop diagram for the configuration required. It is advised that 'Bootlace Ferrules' or 'flat blade crimps' be used for tidy and reliable connections of wires into the Control Unit and Detector Head connectors.

2.3 Power Supply Input

An isolating switch should be provided between the power source and the MCU control units to allow the supply to be easily disconnected. This should incorporate over current protection or a circuit breaker. Alternatively a fused supply would suffice.

2.3.1 A.C. Mains Connection

The power supply board has three screw terminals connector assigned for the connection of an AC supply.

Pin 1 = Earth
Pin 2 = Live input
Pin 3 = Neutral input

Recommendation for mains input cable:

3-Core - Conductors having cross sectional area of 0.75mm² minimum (24/0.2).

2.3.2 DC Voltage Connection

The power supply board has two screw terminals assigned for the connection of a DC supply.

Pin 4 = +24V DC input
Pin 5 = 0V DC input

2.4 Cable Routing

Due to the low signal levels generated by gas detectors it is recommended that all wiring to the sensors be segregated away from AC mains or other high voltage/power lines to avoid interference.

2.5 Cable Screening

The use of a screened cable is recommended for the installation of all detector heads. The screening is used to minimise the effects of electrical interference generated by external equipment e.g. motors, switchgear etc. The correct strategy for connecting the screens depends upon the area in which the detector head is to be used (i.e. hazardous/ non-hazardous). In all cases the screen should not be connected at the detector head.

STATUS SCIENTIFIC CONTROLS

LC Series Controller Installation and Hardware Configuration Manual

3 GAS DETECTOR HEAD INSTALLATION

3.1 Siting the Detectors

Mounting positions for the gas detectors need to be considered individually, Status Scientific Controls will offer advice and assistance with regard to the siting of detectors in varying environments. Some initial points for consideration are:

- Ensure all gas detectors are mounted to allow routine calibration and maintenance to be carried out as required.
Note: Sensors can operate reliably for several years however the environment may reduce the sensor expected life.
- Ensure the proposed site will not interfere with movement of existing equipment, e.g. cranes, doors etc
- Install all cables neatly and securely.
- Detectors for gases that are lighter than air should be positioned at a high level.
- Detectors for gases that are heavier than air should be located at below head height.
- Avoid siting the gas detectors adjacent to potential sources of radio frequency interference, e.g. radio transmitters, control switchgear, motors etc.
- Ensure the detectors are mounted with sufficient space to allow air movement around the sensor section, and the opening of the front hinged lid.

3.2 Installation in a Non-Hazardous Area

Where gas detector heads are to be installed in an area where there is no potential of an explosive gas hazard present, the cable lengths are limited solely by the resistance of the cable. The FGD2, FGD3 or FGD10b gas detectors fitted with either oxygen or toxic sensors require a minimum of 6V at its terminals to operate correctly. The maximum cable loop resistance is therefore $(20-6)/25\text{mA}$ i.e. 560Ω .

Cable resistance values depend upon the size of the cable. Typical resistance values are:

1.0mm ² solid core	40 Ω /Km loop.
1.5mm ² solid core	25 Ω /Km loop.

The correct wiring method for all Status Scientific FGD2 / FGD3 Detector Heads (in a non-hazardous location) is shown below. It is important to note that this drawing shows the wiring connections but does not discuss the Input Module configuration. Prior to connecting the Detector Head ensure the Input Module is correctly configured (refer to section 4.1).

Note:

The screens from each cable are connected to the chassis earth of the control unit. The connection between the system 0V and the earth of the chassis is made by fitting Jumper J1 located on the distribution board.

For installation diagrams for FGD Flammable Gas Detector Heads refer to section 3.3.

STATUS SCIENTIFIC CONTROLS

LC Series Controller Installation and Hardware Configuration Manual

3.3 Installation in a Hazardous Areas

Where gas detector heads are to be mounted within a potentially explosive atmosphere then electrical safety barriers must be fitted in order to limit the electrical energy that is supplied into the hazardous area. This prevents an incendive spark occurring under an electrical fault condition.

When using barriers to create an I.S. supply, certain restrictions are imposed on the parameters of the interconnecting cables used. These parameters are defined by the manufacturer of the barrier and limit the maximum capacitance, inductance and inductance to resistance ratio of the cable. The installation is only intrinsically safe when the combination of the barrier and connecting cables comply with the manufacturer's specification.

As with a non-I.S. installation, the cable length is restricted by the cable loop resistance. With the introduction of a barrier, the cable loop resistance is reduced because of the internal resistance of the barrier. The end to end resistance of the barrier must therefore be subtracted from the overall cable loop resistance when calculating cable lengths.

Barriers must be selected to restrict the parameters of the I.S. supply to the gas detectors within the following limits:

Gas Detector	Terminals	U_{max}	I_{max}	P_{in}
FGD2/3 Oxygen or Toxic	0V and SIG	30V	0.15A	0.81W
FGD2/3 Flammable	0V and SIG	30V	0.15A	0.81W
	0V and PWR+	7.5V	0.75A	1.4W

When considering the capacitance and inductance allowable across the barrier output terminals, note: There is zero capacitance and zero inductance between terminals 0V and SIG on any model of FGD Detector head.

There is an equivalent of 1.4 μ F capacitance and zero inductance between terminals 0V and PWR on the FGD2 and FGD3 flammable gas detectors.

STATUS SCIENTIFIC CONTROLS

LC Series Controller Installation and Hardware Configuration Manual

3.3.1 Hazardous area installations using Safety Barriers.

The following diagrams show how proprietary I.S. barriers can be used (barriers manufactured by MTL are shown).

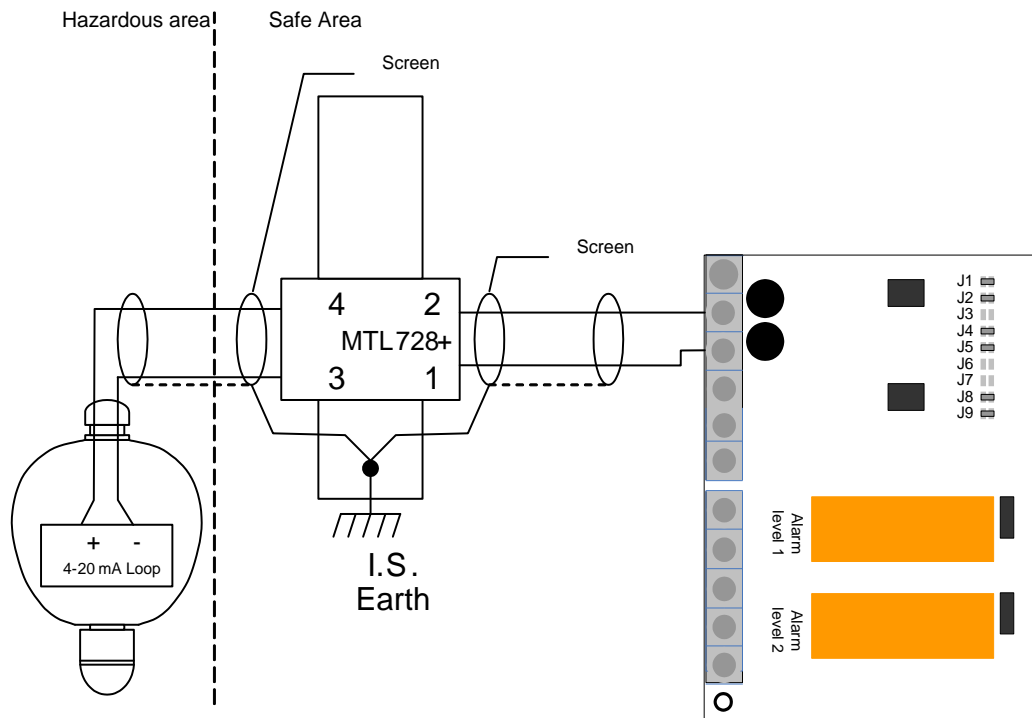
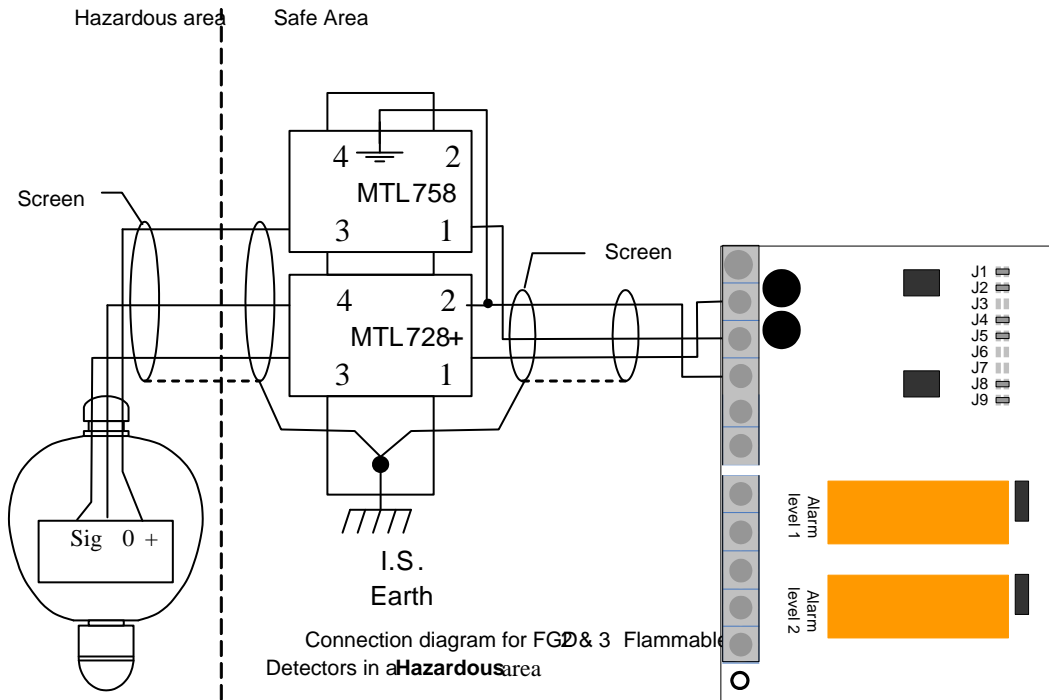

Note:

The system 0V is **NOT** connected to the earth.

STATUS SCIENTIFIC CONTROLS

LC Series Controller Installation and Hardware Configuration Manual

The I.S Earth connection on the power distribution PCB must be connected to the installations' I.S. earth point. The connection must be made via a conductor of minimum 4mm² cross sectional area. Refer to EN60079-14 (previously BS5345:Part 4, section 16) for further details of earthing requirements.

STATUS SCIENTIFIC CONTROLS

LC Series Controller Installation and Hardware Configuration Manual

4 INPUT MODULE CONFIGURATION

The MCU Systems have been designed to cater for almost all requirements of available detector heads. For this reason many of the options available require either software or hardware configuration.

The diagram below shows the Input module and the positions of switches etc required during configuration.

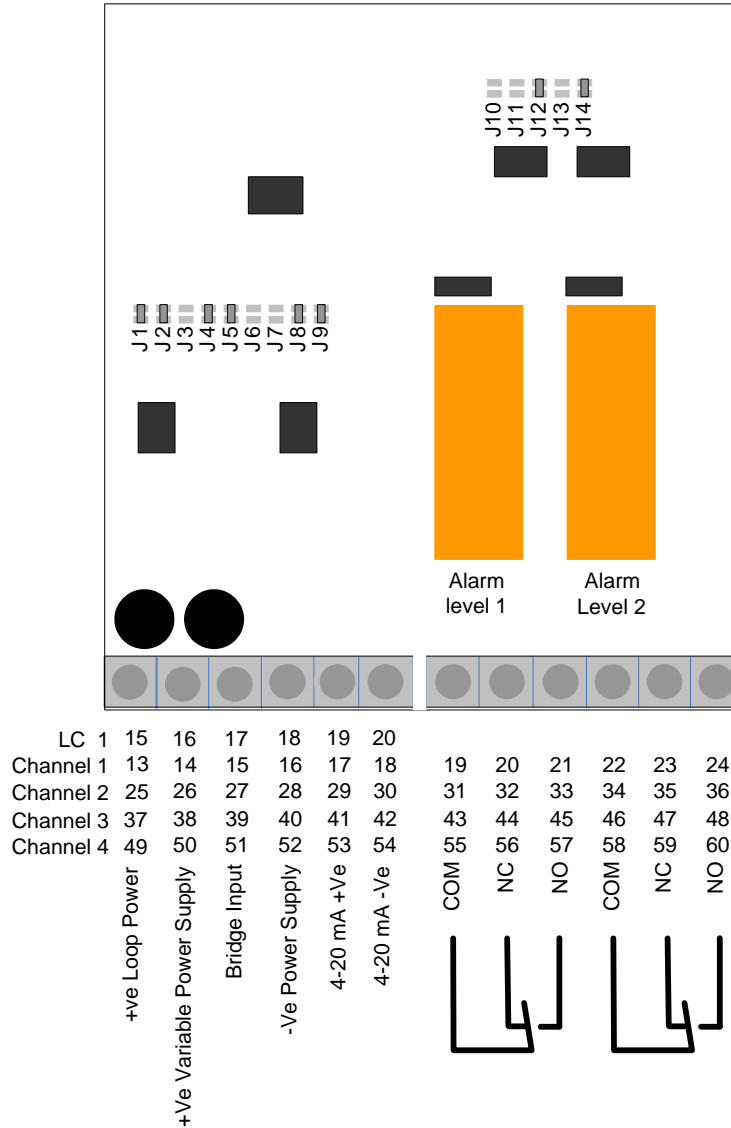

The relay connections shown are with the relay coil in its de-energised state.

Input configuration

- J1 and 9 are for the sensor gain.
- J2, J4, J5, J6, J7 and J8 signal conditioning.

Analogue output

- J10, J12 and J13 is for current sink / source.
- J11 is for voltage output.
- J14 select internal 24V to power the loop.

STATUS SCIENTIFIC CONTROLS

LC Series Controller Installation and Hardware Configuration Manual

4.1 Input Configuration

Section 4.2 discusses the most common configuration options. These are also the configurations adopted by Status Scientific for use with FGD detector heads (manufactured by Status Scientific Controls).

Note: The input configurations shown are for detector heads located in non-hazardous environments. I.S. Barriers are required when mounting in areas where there is a flammable gas hazard, refer to section 3.3.

4.2 Status Scientific Controls Gas Detectors

Status Scientific Controls design and manufacture a variety of fixed gas detectors. The detector head used for monitoring oxygen or toxic gases (using conventional sensors) requires a 2-wire connection whilst detector heads incorporating infrared sensors or pellistors require a 3-wire connection.

4.2.1 FGD2, FGD3, FGD4 and FGD10b O₂ and Toxic Detector Heads

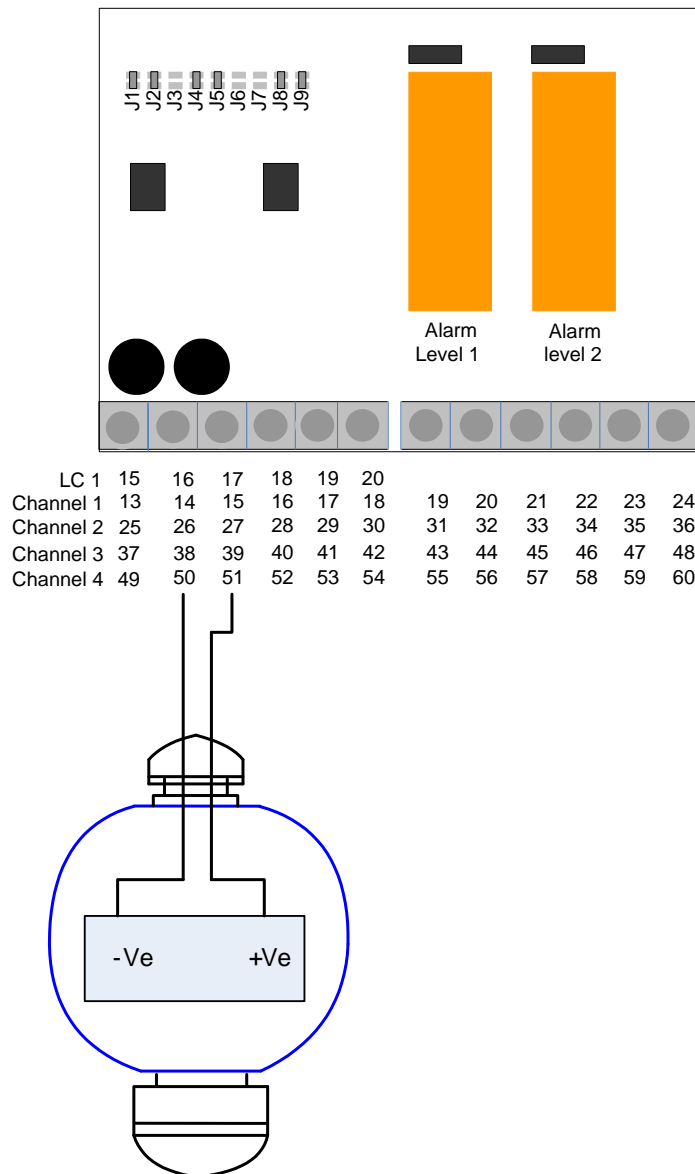

STATUS SCIENTIFIC CONTROLS

LC Series Controller Installation and Hardware Configuration Manual

Connection Procedure

- Disconnect power from the system.
- Remove the terminal cover to gain access to the wiring.
- Remove the terminal cover and display module to gain access to the configuration link settings.
- Configure the jumper switches as shown below (i.e. J1, J2, J4, J5, J8 and J9 switched ON, all others OFF)



- Connect the wires from the detector head to connector on the input module observing the following:

Detector Head Label 4-20mA Loop	Channel 1 Pin Number	Channel 2 Pin Number	Channel 3 Pin Number	Channel 4 Pin Number
-	14	26	38	40
+	15	27	39	51

- Connect power to the system and ensure the detector head operates (text on LCD display, LED will flash once every six seconds approximately).
- Perform software configuration (refer to 'LC Software Configuration and System Calibration Manual').
- Perform system calibration (refer to 'LC Software Configuration and System Calibration Manual').

STATUS SCIENTIFIC CONTROLS

LC Series Controller Installation and Hardware Configuration Manual

4.2.2 FGD3 Infrared Gas Detector Head

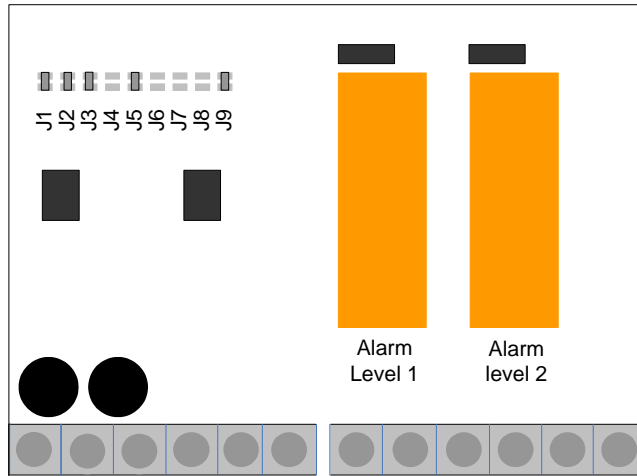

LC 1	15	16	17	18											
Channel 1	13	14	15	16	17	18	19	20	21	22	23	24			
Channel 2	25	26	27	28	29	30	31	32	33	34	35	36			
Channel 3	37	38	39	40	41	42	43	44	45	46	47	48			
Channel 4	49	50	51	52	53	54	55	56	57	58	59	60			

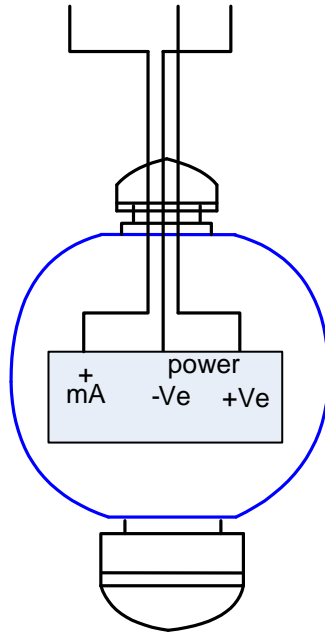

Note: Adjust the voltage between terminals 15 & 16, 27 & 28, 39, & 40, 51 & 52 channels 1, 2, 3, 4 to that of the requirements of the FGD3, usually between 5.8 and 7.5V – see the LC Series Software Manual.

STATUS SCIENTIFIC CONTROLS

LC Series Controller Installation and Hardware Configuration Manual

4.2.3 FGD3 Pellistor Gas Detector Head

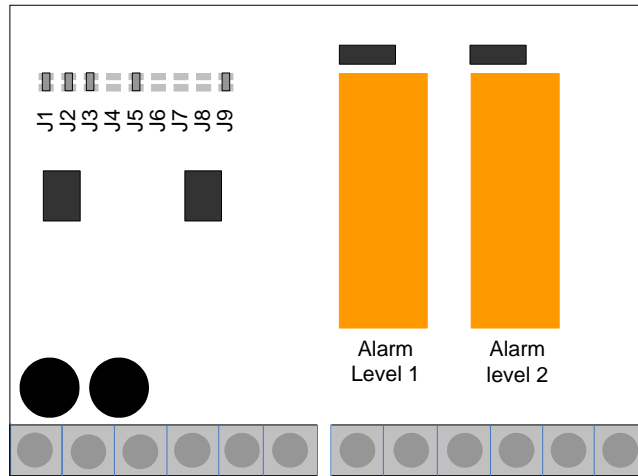

LC 1	15	16	17	18										
Channel 1	13	14	15	16	17	18	19	20	21	22	23	24		
Channel 2	25	26	27	28	29	30	31	32	33	34	35	36		
Channel 3	37	38	39	40	41	42	43	44	45	46	47	48		
Channel 4	49	50	51	52	53	54	55	56	57	58	59	60		

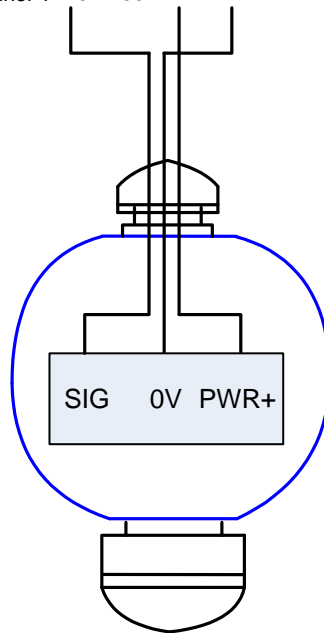

Note: Adjust the voltage between terminals 15 & 16, 27 & 28, 39, & 40, 51 & 52 channels 1, 2, 3, 4 to that of the requirements of the FGD3 Pellistor, usually between 4.0 and 5.0V – see the LC Series Software Manual.

STATUS SCIENTIFIC CONTROLS

LC Series Controller Installation and Hardware Configuration Manual

4.2.4 FGD4, FGD9, FGD10a, FGD10b Gas Detector Heads

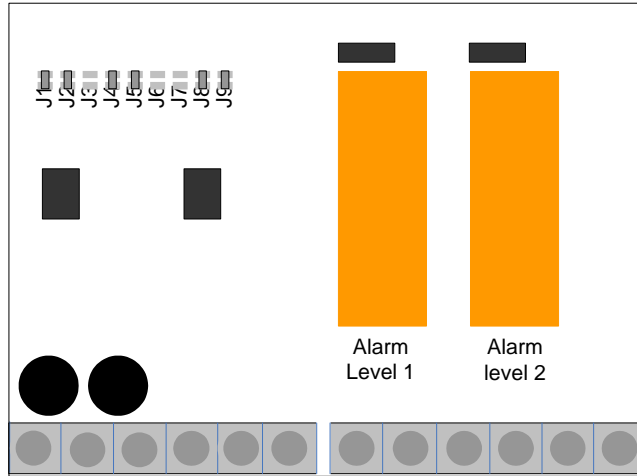

LC1	15	16	17	18											
Channel 1	13	14	15	16	17	18	19	20	21	22	23	24			
Channel 2	25	26	27	28	29	30	31	32	33	34	35	36			
Channel 3	37	38	39	40	41	42	43	44	45	46	47	48			
Channel 4	49	50	51	52	53	54	55	56	57	58	59	60			

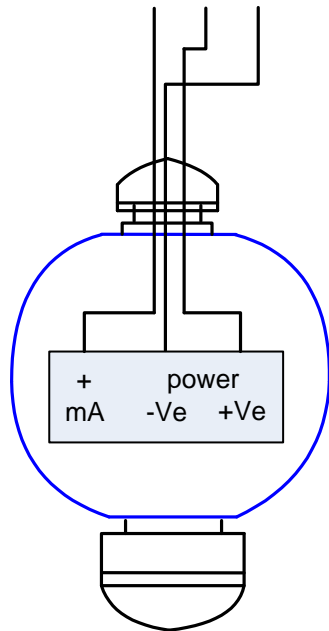

Connection Procedure

- Disconnect power from the system.
- Remove the terminal cover to gain access to the wiring.
- Remove the terminal cover and display module to gain access to the configuration switch settings.
- Configure the jumper switches as shown below (i.e. J1, J2, J4, J5, J8 and J9 switched ON, all others OFF)



STATUS SCIENTIFIC CONTROLS

LC Series Controller Installation and Hardware Configuration Manual

- Connect the wires from the detector head to connector on the input module observing the following:

Detector Head	Channel 1 Pin Number	Channel 2 Pin Number	Channel 3 Pin Number	Channel 4 Pin Number
Aout +	14	26	38	50
PSU +	15	27	39	51
PSU -	16	28	40	52

- Connect power to the system and ensure the detector head operates (text on LCD display, LED will flash once every six seconds approximately)
- Measure the voltage between the + and 0 terminals at the detector head.
- If necessary adjust the voltage to give 9 to 10V at the detector head. (refer to 'LC Software Configuration and System Calibration Manual').
- Refit grey protective cover.
- Perform software configuration (refer to 'LC Software Configuration and System Calibration Manual').
- Perform system calibration.

Note: FGD4, FGD10b infrared current source version.

STATUS SCIENTIFIC CONTROLS

LC Series Controller Installation and Hardware Configuration Manual

4.2.5 Pellistor Only Gas detectors

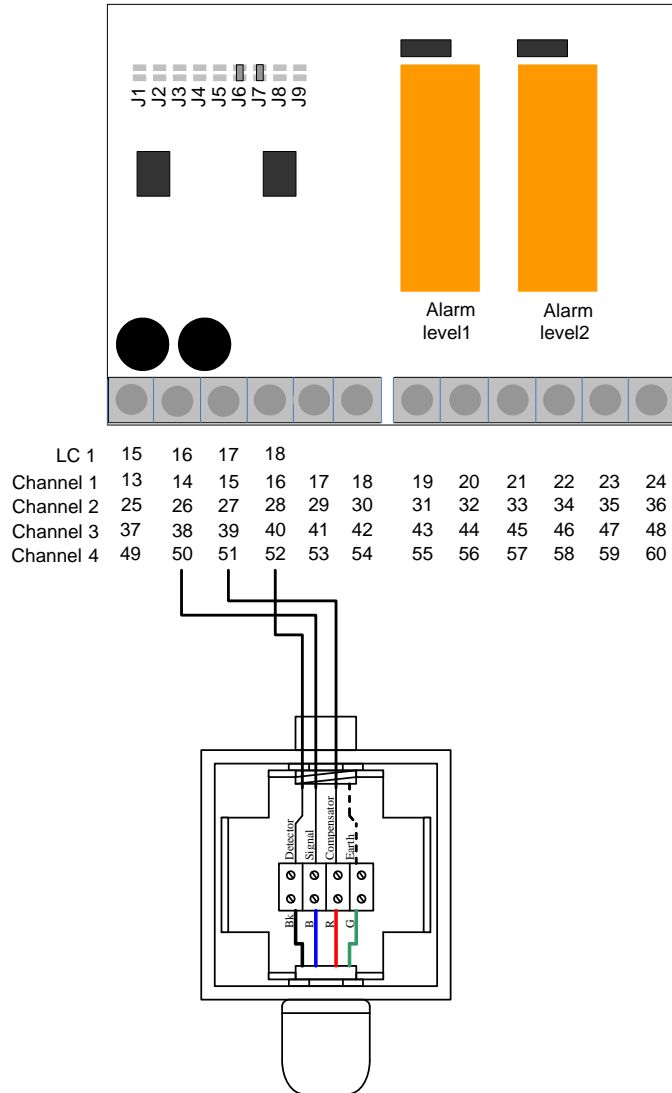

Connection Procedure

Note: For use in hazardous areas, the pellistors must be housed in an Exd enclosure mounted on an Exe terminal housing.

- **DO NOT** connect the pellistors at this time.
- Configure the links as shown below (i.e. J6 & J7 ON, all others OFF)



- Connect the wires from the detector head to connector on the input module observing the following:
- Connect a voltmeter between pins compensator (+V) and Detector (0V).
- Adjust the voltage to match the pellistor type. (refer to the 'LC Software Configuration and System Calibration Manual').

Note: Connecting a voltage of greater than the recommended level can cause irreparable damage to the pellistors.

STATUS SCIENTIFIC CONTROLS

LC Series Controller Installation and Hardware Configuration Manual

Detector Head	Channel 1 Pin Number	Channel 2 Pin Number	Channel 3 Pin Number	Channel 4 Pin Number
Signal	14	26	38	50
Compensator	15	27	39	51
Detector	16	28	40	52

- Connect the pellistors to the input module observing the above diagram.
- Check that the voltage across the pellistors remains at the pellistor operating voltage \pm 0.05V, adjust if necessary.
Note: Measure the voltage at the pellistors, not at the input module terminals.
- Perform software configuration (refer to 'LC Software Configuration and System Calibration Manual').
- Perform system calibration.

STATUS SCIENTIFIC CONTROLS

LC Series Controller Installation and Hardware Configuration Manual

4.2.6 FGD56-IR

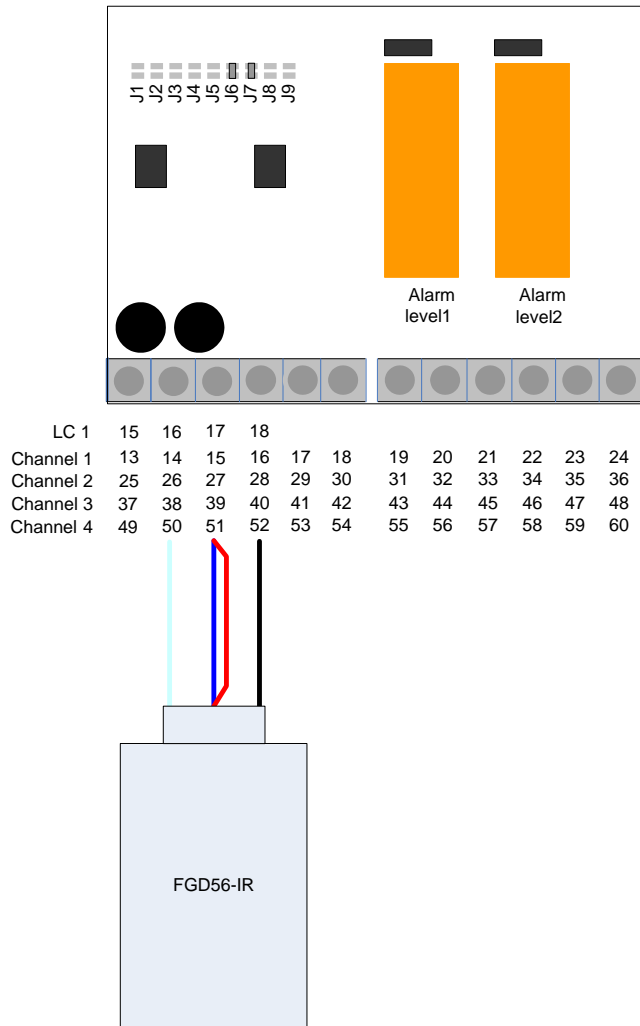

Connection Procedure

Note: For use in hazardous areas, the FGD56-IR must be mounted on an Exe terminal housing.

- Configure the links as shown below (i.e. J6,J7 fitted, all others removed)



- Connect a voltmeter between pins Power +ve (pin 14) and 0V (pin 16).
- Adjust the voltage to between 4.5 and 5.5V, typically 5.0V (refer to 'LC Software Configuration and System Calibration Manual').
- **Note: Connecting a voltage of greater than the recommended level can cause irreparable damage to the FGD56-IR.**
- Connect the pellistors to the input module observing the diagram below.
- Check that the voltage across the pellistors remains at the specified voltage $\pm 0.05V$, adjust if necessary.
- **Note: Measure the voltage at the FGD56-IR, not at the input module terminals.**
- Perform software configuration (refer to 'LC Software Configuration and System Calibration Manual').
- Perform system calibration.

Note: The FGD56-IR gas detector should have the signal set to rising, connect the blue wire to the red wire.

STATUS SCIENTIFIC CONTROLS

LC Series Controller Installation and Hardware Configuration Manual

4.3 Analogue Output Configuration

In addition to providing the connections for various connector types, the Input Module can also provide an analogue output. This output mimics the signal detected so that it may be used by external equipment (e.g. chart recorders, data loggers) for a variety of purposes.

Note: It is important to ensure that the Analogue Output is calibrated if in use (refer to 'MCU Software Configuration and System Calibration Manual').

4.3.1 4-20mA Current Source

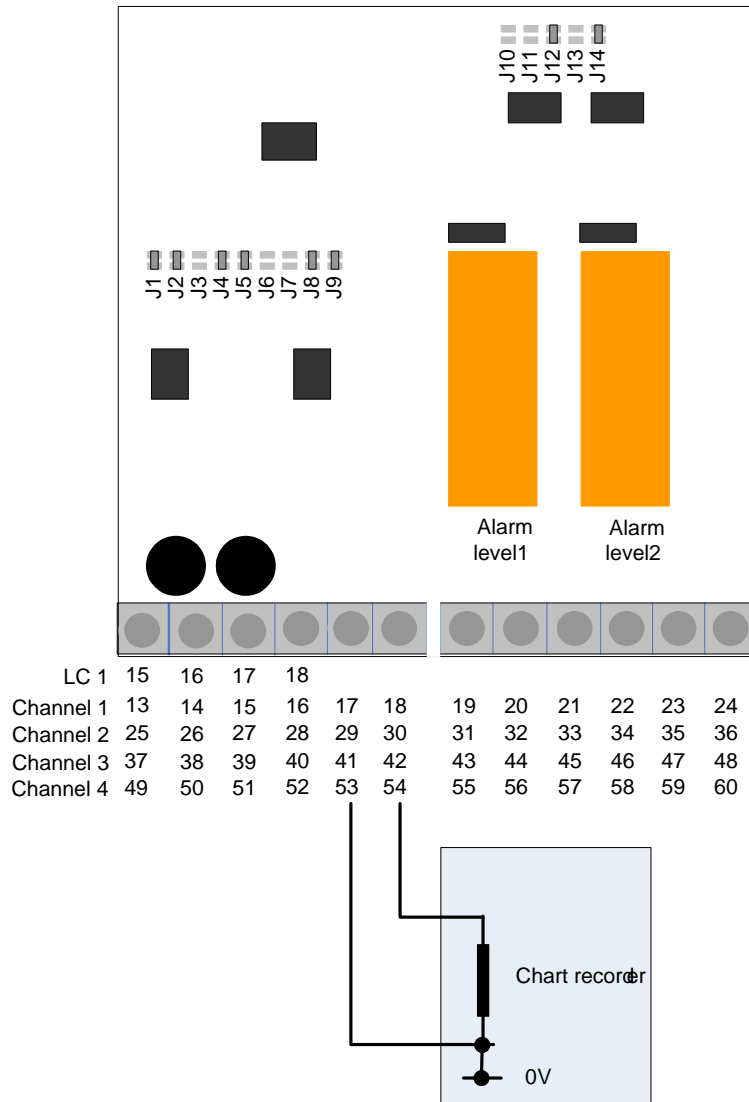

The Input Module sources current proportional to the detected gas level.

i.e. zero gas = 4mA
 full scale = 20mA

The supply is taken from the internal PSU. Switch ON J12 and J14



NOTE: Incorrect jumper switch configuration can cause damage to the system.

STATUS SCIENTIFIC CONTROLS

LC Series Controller Installation and Hardware Configuration Manual

4.3.2 4-20mA Current Sink

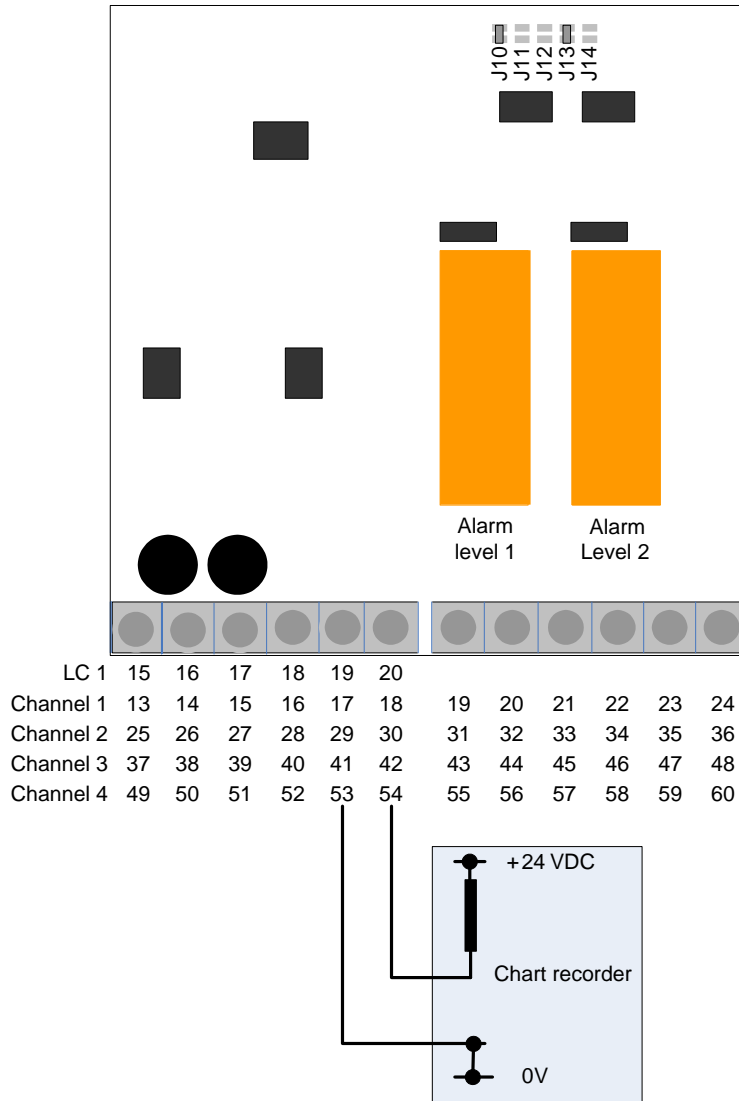

The Input Module can also sink current proportional to the detected gas level.
 i.e. zero gas = 4mA
 full scale = 20mA

The supply is derived from the external equipment.

Notes

Switch ON J10 and J13

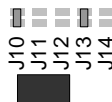

NOTE: Incorrect jumper switch configuration can cause damage to the system.

STATUS SCIENTIFIC CONTROLS

LC Series Controller Installation and Hardware Configuration Manual

4.3.3 1-5V Voltage Output

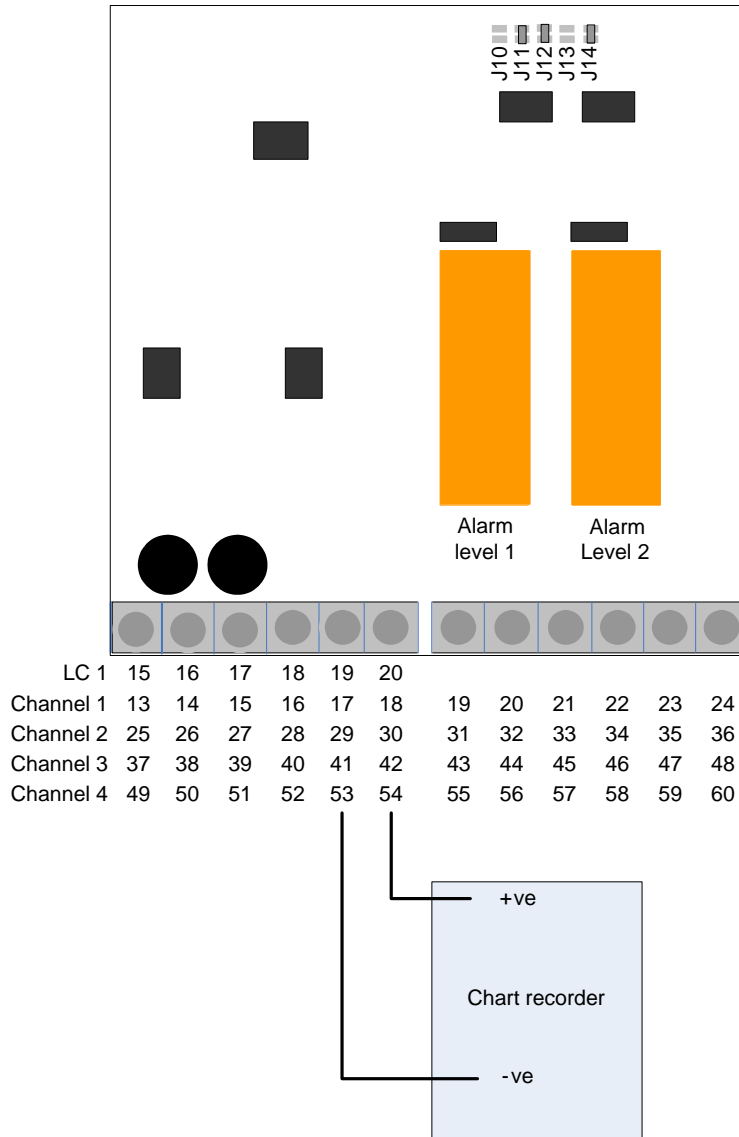

The LC Control Unit can provide a voltage output.

i.e. zero gas = 1V
full scale = 5V

This output is not ideal when transmitting a signal over a large distance. The resistance of a cable attached will cause a voltage drop to occur.

Switch ON J11, J12 and J14.

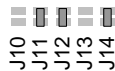

NOTE: Incorrect jumper switch configuration can cause damage to the system.

STATUS SCIENTIFIC CONTROLS

LC Series Controller Installation and Hardware Configuration Manual

5 ROUTINE SERVICING

The MCU Control Unit will provide a reliable and fault free service but they rely upon sensible housekeeping and regular calibrations.

It is recommended that the system be calibrated **at least** once every six months. This can be arranged with Status Scientific Controls as part of a maintenance contract.

5.1 Routine Inspection

It is advisable to periodically inspect the LC Control Unit Installation:

- Check cables to ensure no damage has occurred.
- Clean control unit casing using a clean cloth.
- Clean detector heads using a clean DAMP cloth.
Note: Use of a dry cloth would constitute a static hazard.
- Inspect detector heads and ensure the sensor housings aperture is not obstructed.

Note: Do not use solvents to clean the LCD display window on the control units or the detector heads.

The time interval between routine inspections will depend upon the area in which the equipment is installed. A clean laboratory installation may only require inspection at the time of calibration, whereas an installation in a particularly dirty environment may require weekly inspections. It is the responsibility of the system engineer to assess the installation environment and determine the frequency of routine inspections.

STATUS SCIENTIFIC CONTROLS

LC Series Controller Installation and Hardware Configuration Manual

6.2 LC2 Control Unit

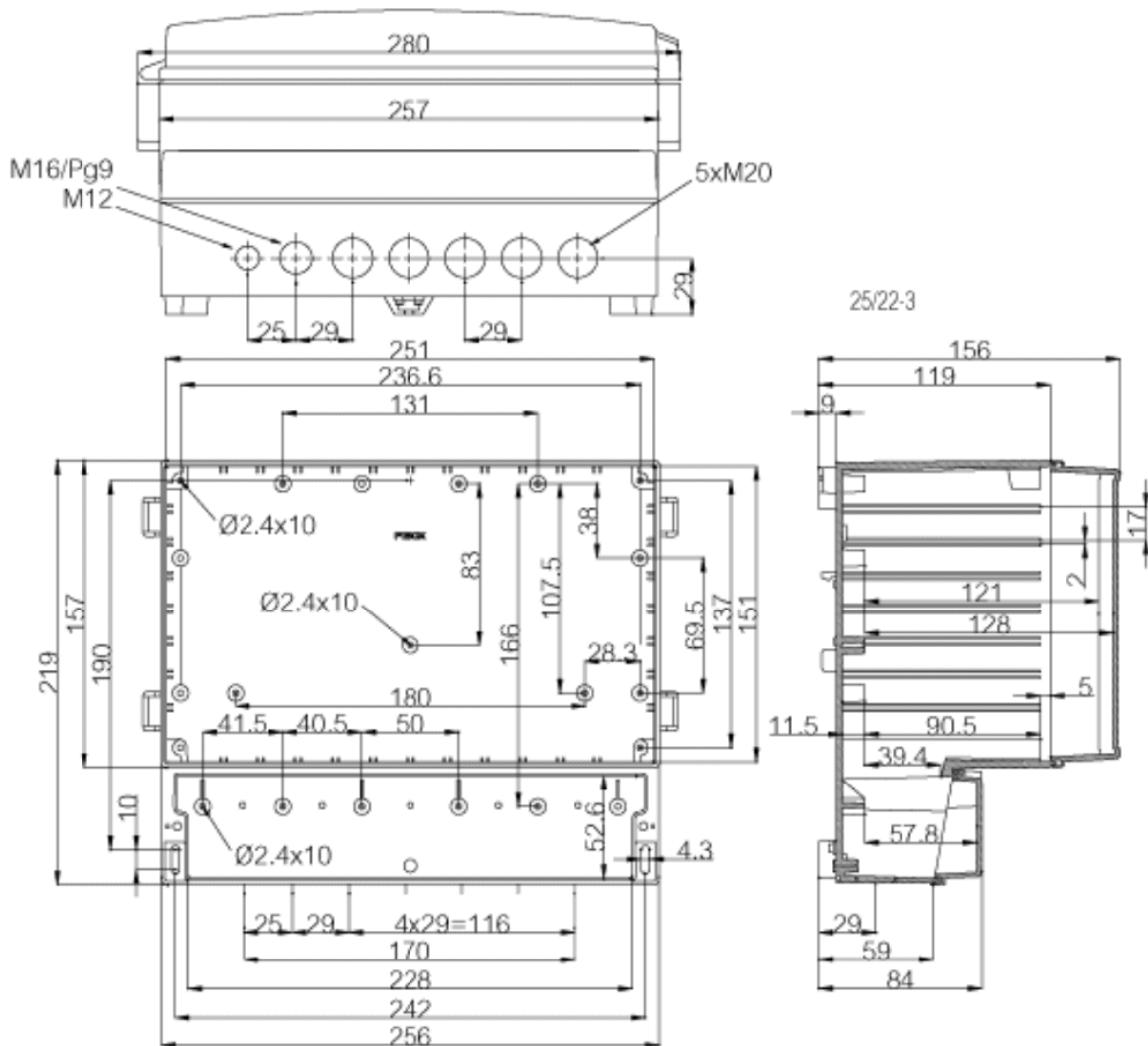

STATUS SCIENTIFIC CONTROLS

LC Series Controller Installation and Hardware Configuration Manual

6.3 LC4 Control Unit

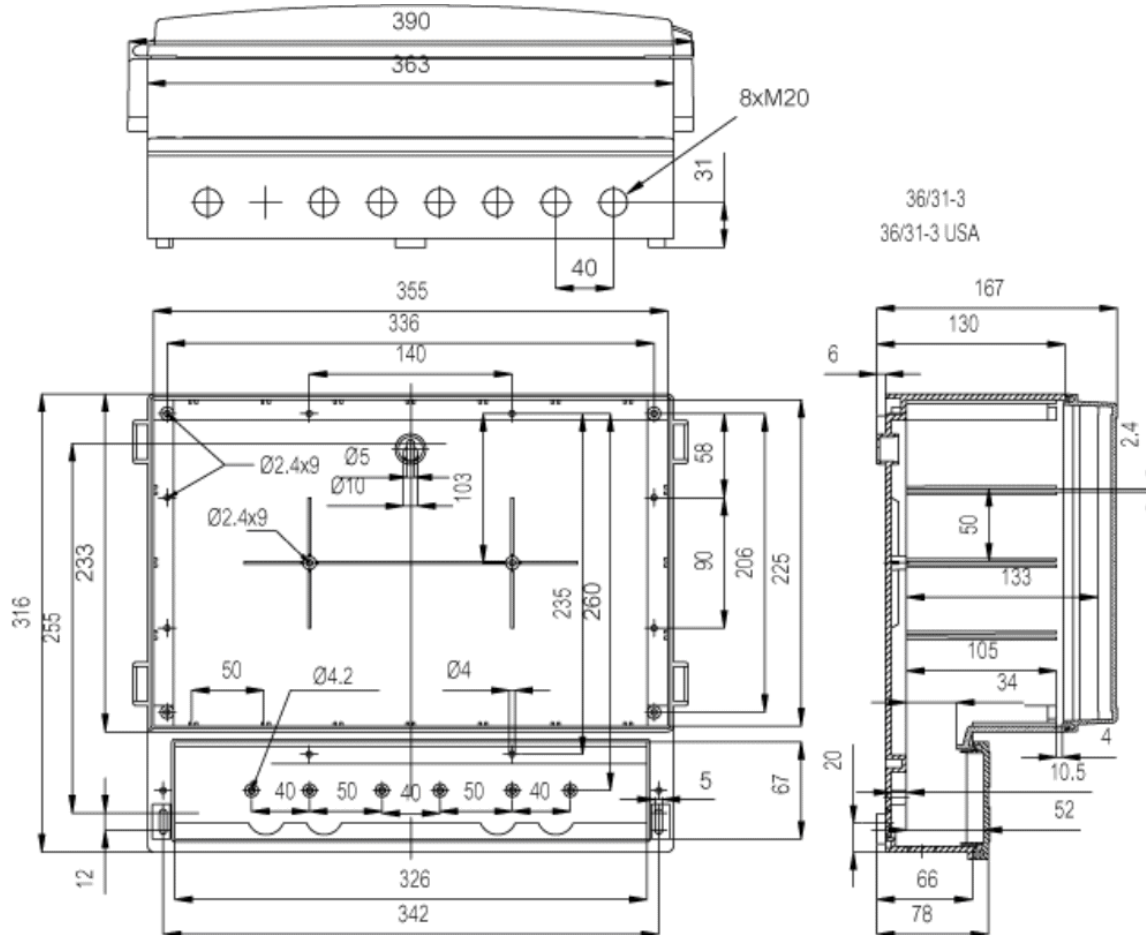

STATUS SCIENTIFIC CONTROLS

LC Series Controller Installation and Hardware Configuration Manual

7 SPECIFICATIONS

7.1 LC1 Control Unit

Type	LC1
Size (nominal) 'mm'	188 x 160 x 106
Weight (approx)	
Operating Temp	-10°C to +50°C
Storage Temp	-20°C to +50°C
Humidity Range	0 to 95% R.H. Non-condensing
Input Voltage	18-28V DC, or 100-240V AC 50/60 Hz
Environmental Rating	IP65

User Interface	
Display	Backlit 122 x 32 dot Liquid Crystal Display (LCD)
Keyboard	4 button multifunction keypad
LED Indications Option 1	Red Indicates alarm condition. Yellow Indicates fault condition. Green Indicates power ON
LED Indications Option 2	Red Indicates alarm level 1 condition. Red Indicates alarm level 2 condition. Yellow Indicates fault condition.

Input Modules	
Number of channels	1 max
Signal Input	4-20mA Current Loop from 24V source. 4-20mA Current Loop sink to 0V. 3-Wire Pellistor Systems.
Analogue Output	4-20mA Current source proportional to detected signal. 4-20mA Current sink proportional to detected signal. 1-5V Voltage output proportional to detected signal.
3 – Relays	1 relay assigned to alarm level 1. 1 relay assigned to alarm level 2. 1 relay assigned to fault condition.
Contacts Rating	Single Pole Changeover Contacts (voltage free). 5A 240V AC.

Power Supply	
Fuse 1 (AC Input)	T1.0A
Fuse 2 (24VDC input)	T500mA

STATUS SCIENTIFIC CONTROLS

LC Series Controller Installation and Hardware Configuration Manual

7.2 LC2 Control Unit

Type	LC2
Size (nominal) 'mm'	280 x 219 x 156
Weight (approx)	1.9Kg
Operating Temp	-10°C to +50°C
Storage Temp	-20°C to +50°C
Humidity Range	0 to 95% R.H. Non-condensing
Input Voltage	18-28V DC, or 100-240V AC 50/60
Environmental Rating	IP65

User Interface	
Display	Backlit 122 x 32 dot Liquid Crystal Display (LCD)
Keyboard	4 button multifunction keypad
LED Indications Option 1	Red Indicates alarm condition. Yellow Indicates fault condition. Green Indicates power ON
LED Indications Option 2	Green Indicates power ON Red Indicates alarm level 3 condition. Red Indicates alarm level 2 condition. Red Indicates alarm level 1 condition. Yellow Indicates fault condition.

Input Modules	
Number of channels	2 max
Signal Inputs x 2	4-20mA Current Loop from 24V source. 4-20mA Current Loop sink to 0V. 3-Wire Pellistor Systems.
Analogue Output x 2	4-20mA Current source proportional to detected signal. 4-20mA Current sink proportional to detected signal. 1-5V Voltage output proportional to detected signal.
6 – Relays	1 relay assigned to alarm level 1, channel 1 & 2. 1 relay assigned to alarm level 2, channel 1 & 2. 1 relay assigned to common alarm level 3.
Contacts Rating	1 relay assigned to fault condition. Single Pole Changeover Contacts (voltage free). 5A 240V AC.

Power Supply	
Fuse 1 (AC Input)	T1.0A
Fuse 2 (24VDC input)	T500mA

STATUS SCIENTIFIC CONTROLS

LC Series Controller Installation and Hardware Configuration Manual

7.3 LC4 Control Unit

Type	LC4
Size (nominal) 'mm'	390 x 316 x 167
Weight (approx)	3.8Kg
Operating Temp	-10°C to +50°C
Storage Temp	-20°C to +50°C
Humidity Range	0 to 95% R.H. Non-condensing
Input Voltage	18-28V DC, or 100-240V AC 50/60 Hz
Environmental Rating	IP65

User Interface	
Display Option 1	LED Backlit 122 x 32 dot Liquid Crystal Display (LCD)
Display Option 2	LED Backlit 240 x 128 dot Liquid Crystal Display (LCD)
Keyboard	4 button multifunction keypad
LED Indications Option 1	Red Indicates alarm condition. Yellow Indicates fault condition. Green Indicates power ON
LED Indications Option 2	Green Indicates power ON Red Indicates alarm level 3 condition. Red Indicates alarm level 2 condition. Red Indicates alarm level 1 condition. Yellow Indicates fault condition.

Input Modules	
Number of channels	4 max
Signal Inputs x 4	4-20mA Current Loop from 24V source. 4-20mA Current Loop sink to 0V. 3-Wire Pellistor Systems.
Analogue Output x 4	4-20mA Current source proportional to detected signal. 4-20mA Current sink proportional to detected signal. 1-5V Voltage output proportional to detected signal.
10 – Relays	1 relay assigned to alarm level 1, channel 1, 2, 3 & 4. 1 relay assigned to alarm level 2, channel 1, 2, 3 & 4. 1 relay assigned to common alarm level 3.
Contacts Rating	1 relay assigned to fault condition. Single Pole Changeover Contacts (voltage free). 5A 240V AC.

Power Supply	
Fuse 1 (AC Input)	T1.0A
Fuse 2 (24VDC input)	T500mA